



A-PDF N-up Page

Make creating N-up (2-up, 4-up etc...) PDF files
User Documentation

Note: This product is distributed on a 'try-before-you-buy' basis. All features described in this documentation are enabled. The registered version does not insert a watermark in your extracted image files.

About A-PDF N-up Page

A-PDF N-up Page (Impose) is a simple, lightning-fast desktop utility program that lets you to batch make creating N-up (2-up, 4-up etc...) PDF files as easy as drag-and-drop, It combines\rearrange PDF pages onto larger (or custom size) sheets to make books, booklets, or special arrangements. Making a foldable booklet from a PDF or arranging complex imposition layouts couldn't be easier. A-PDF N-up Page will do the task for you

A-PDF N-up Page does NOT require Adobe Acrobat.

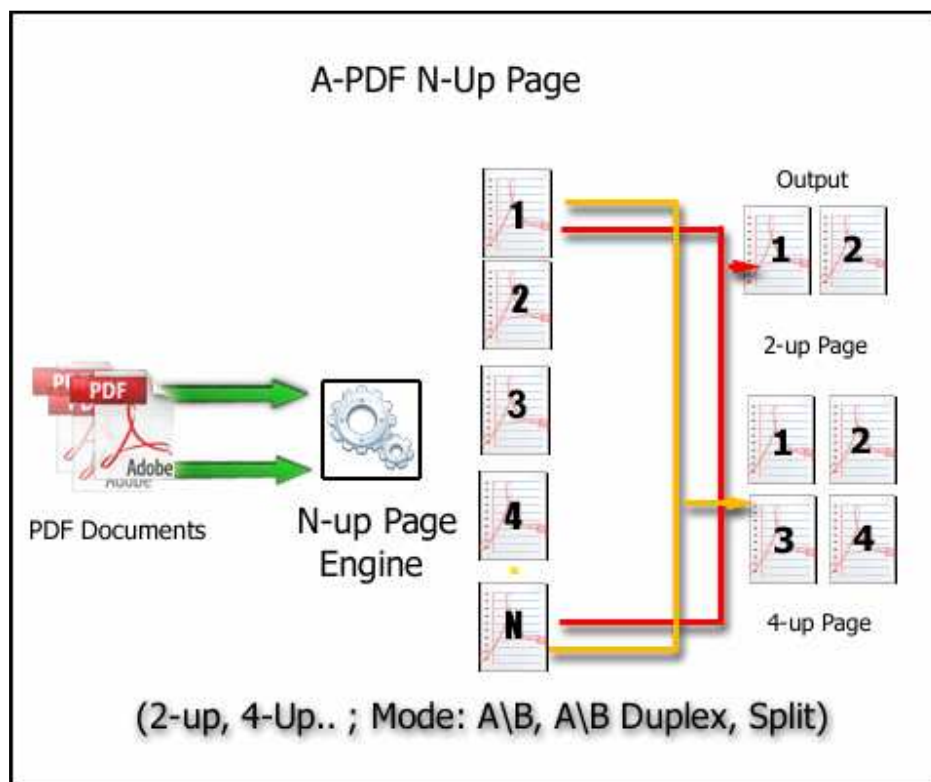

Why A-PDF N-up Page

To create booklets, you must combine multiple pages in an array that's ready for printing. Traditional imposition software has been designed forward professional users.



A-PDF N-up Page

Make creating N-up (2-up, 4-up etc...) PDF files
User Documentation

A-PDF n-up page enables anyone to master the imposition (n-up page) process without professional training or complex job setups. You'll be able to arrange pages on larger sheets, rearrange pages, trim pages and accomplish a whole range of imposition tasks –and do it all without Acrobat PDF files.

Features

- Powerful Batch PDF imposition tool for professional layout control and PDF booklet making
- N-up, 2-up or 4-up to create imposed PDF files that meet your production needs. Control sheet size, margins, gutters, and so on
- 2-up PDFs or 4-up PDFs
- Supports A/B or Split type imposition
- Order page: Across or Down the page
- Rotate page: Rotate all, odd or even pages option
- Supports Adjust margins between each page
- Supports "Drag and Drop" support of PDF files
- Custom output PDF Page Size (Scaling, Fit to page size, remain original page size) while N-UP PDF pages

Using A-PDF N-up Page

A-PDF N-up Page can be started either by launching the application via a desktop shortcut, or directly from within Windows/Windows Explorer.



When you start the program, you will be presented with the primary screen from which all actions are taken.



A-PDF N-up Page Make creating N-up (2-up, 4-up etc...) PDF files User Documentation

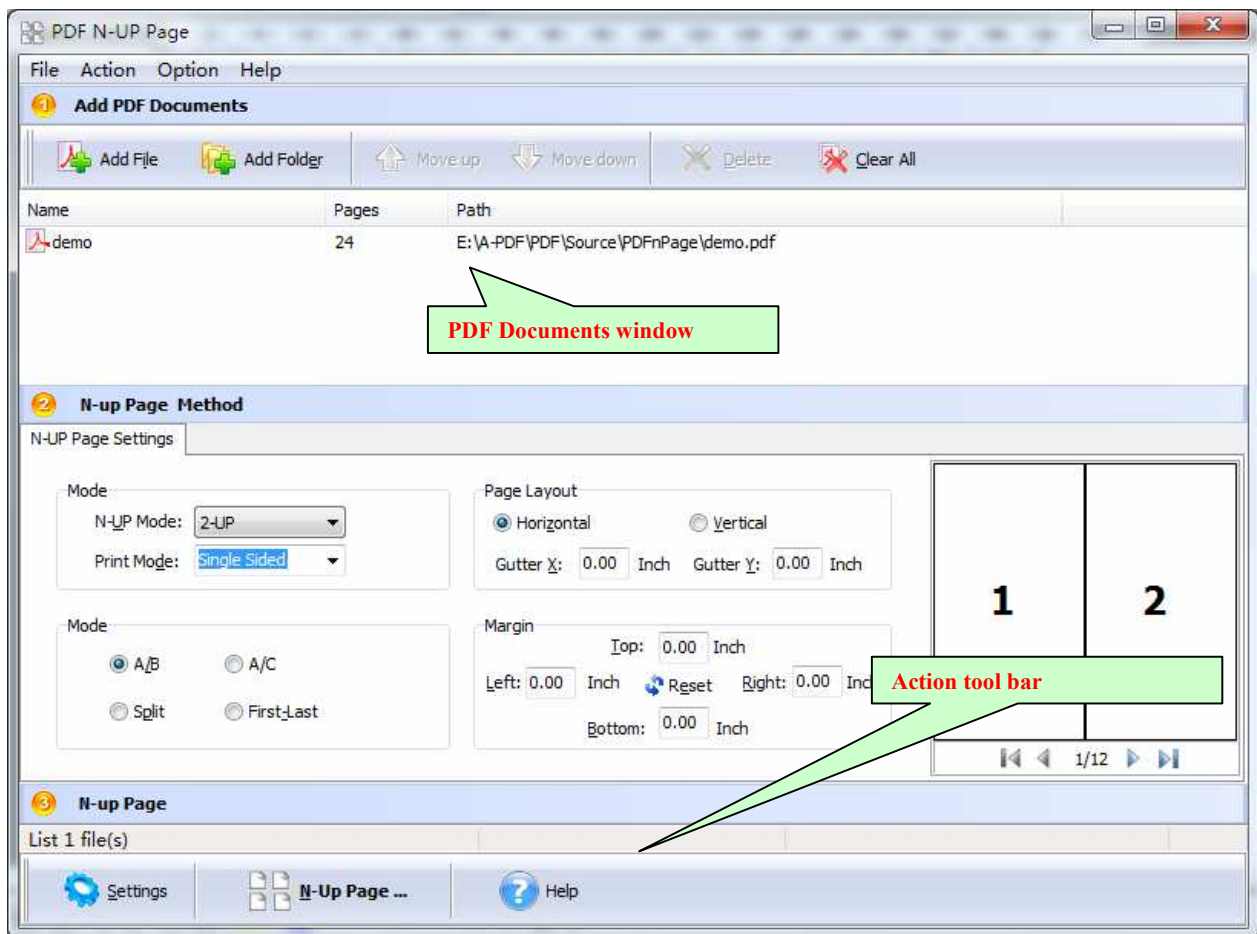

Selecting a File

Clicking the **Add PDF Document** icon , or selecting **File** then choosing **Add PDF Document** will open the standard file browse and select window. From that window you can navigate to the folder and find the files you want to add to the list of files to be n-up page from.

Alternatively, if you are using Windows Explorer to locate files, you have the convenience of being able to 'drag and drop' files into the document window. A-PDF N-up Page even allows you

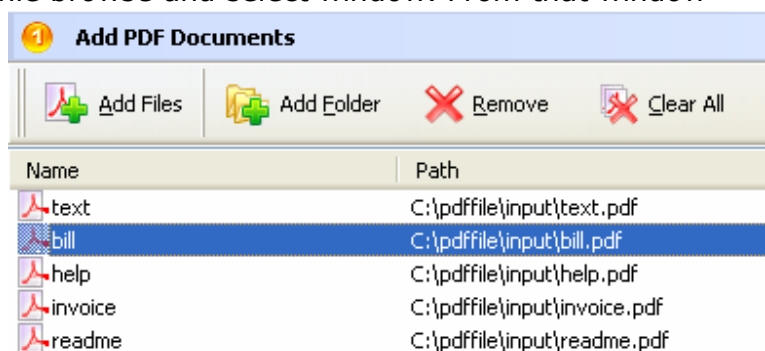



A-PDF N-up Page Make creating N-up (2-up, 4-up etc...) PDF files User Documentation

to select all files in a particular directory/folder by using the **Add a Directory**  option from the **File** menu! Add a directory also supports sub-folders.

Each added file is displayed in the A-PDF N-up Page top window, as seen in the example below. You can view any of the files in the window by 'double-clicking' them. That will open pdf files in your default pdf reader program (usually Adobe Reader).

Select N-up Page Method

N-up: Select 2-up page or 4-up page method

Mode: A/B, A/B (duplex), split

Page layout: Vertical -parameter for 2up'ing downwards on a page rather than across the page (left, right), control sheet size, margins, gutters, and so on

Margin: the output page size can also be controlled and the 2nd page position can be offset with margin controls.



Option

Custom output PDF Page Size (Scaling, Fit to page size, remain original page size) while N-UP PDF pages

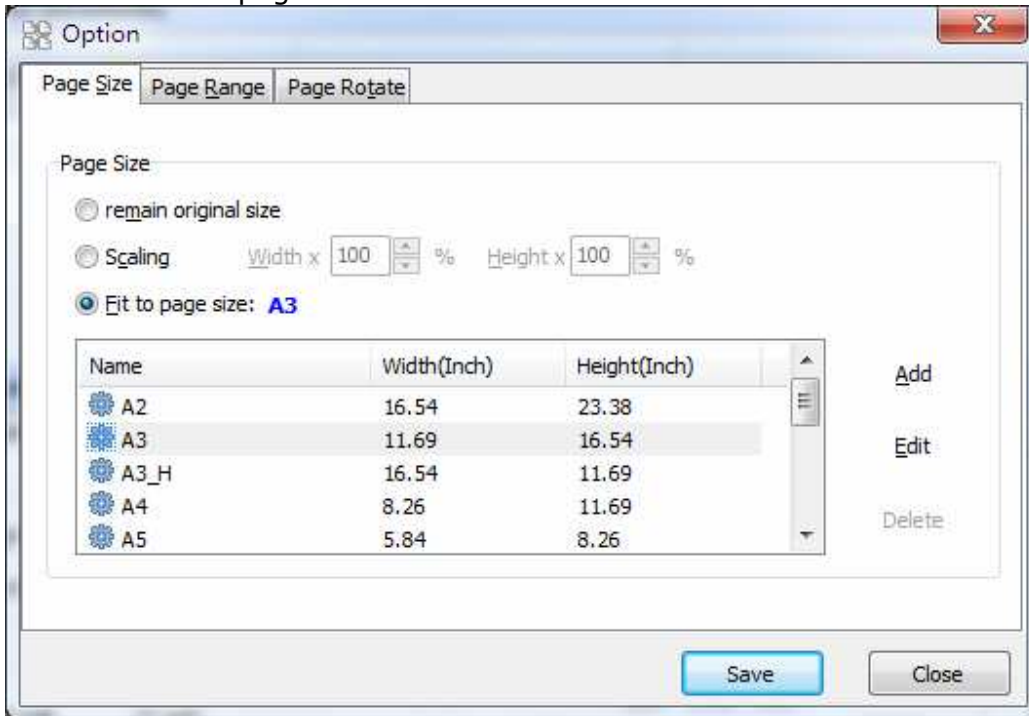



A-PDF N-up Page

Make creating N-up (2-up, 4-up etc...) PDF files
User Documentation

Define Page range (All pages, Odd Pages, Even Pages) for N-UP

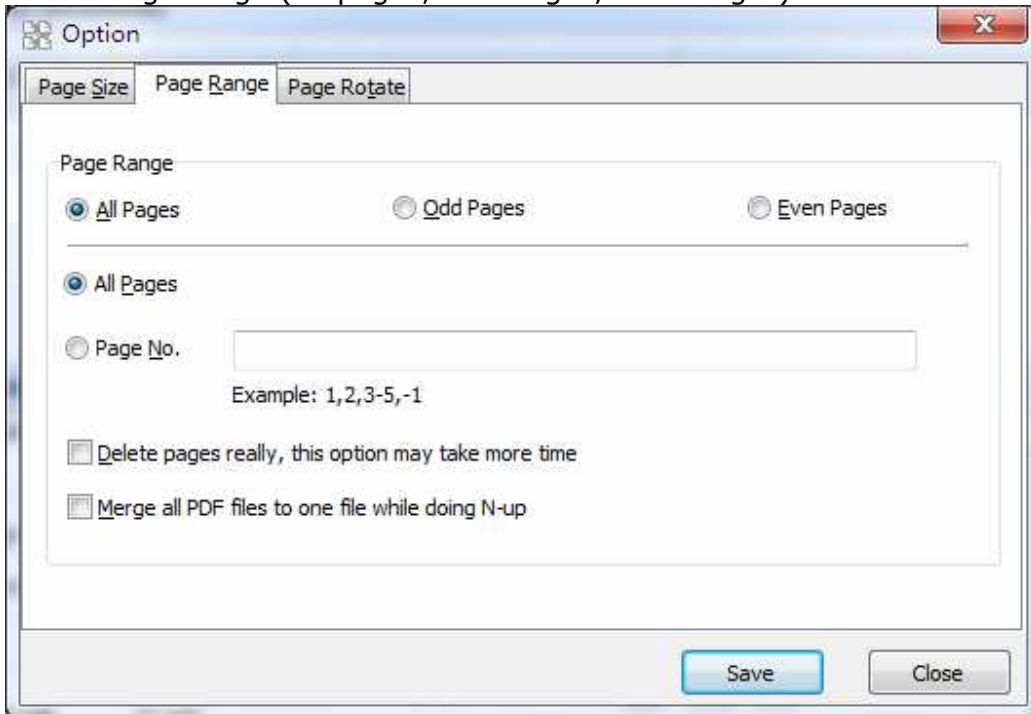



Define Page Rotate before for N-UP

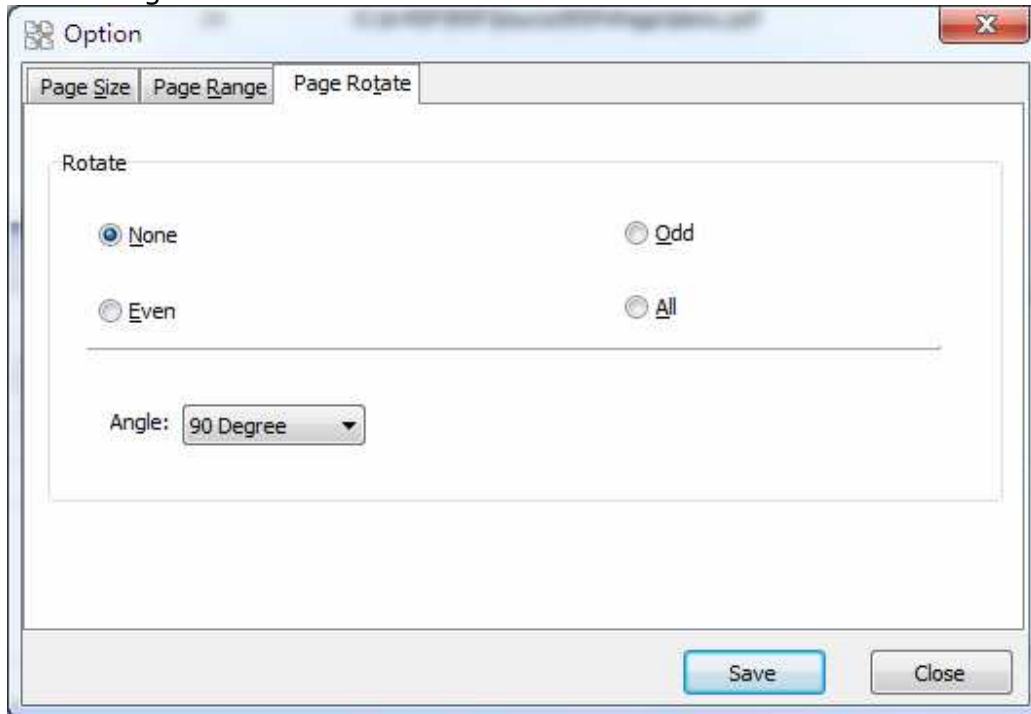

N-Up Page PDF

Click the **N-up Page...** button

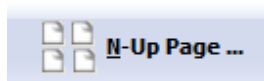

to n-page all of PDF files in the PDFs document windows.

Ending Your Session

When you have completed your work, choose the **File** option and select **Exit** from the dropdown list.

For more information: <http://www.a-pdf.com>